

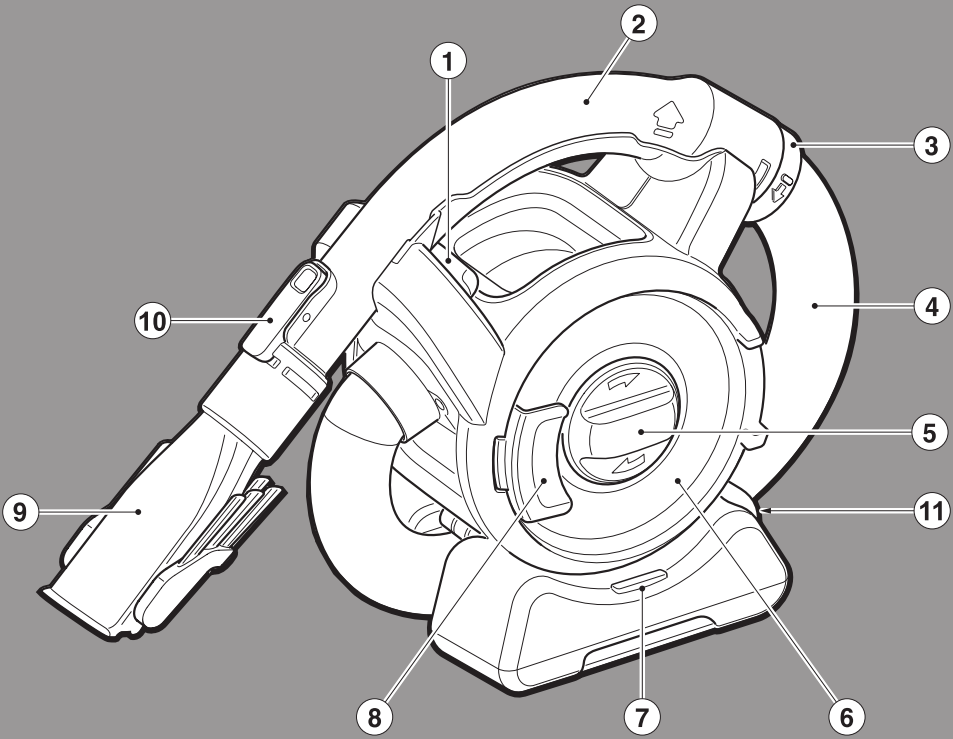

BLACK & DECKER®

EN

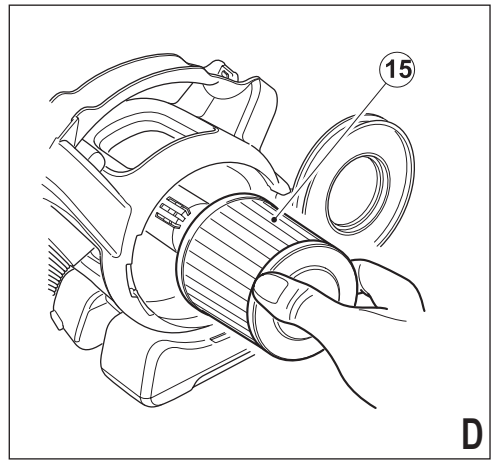

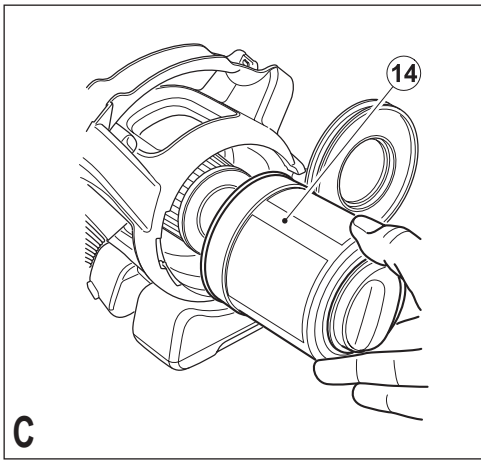
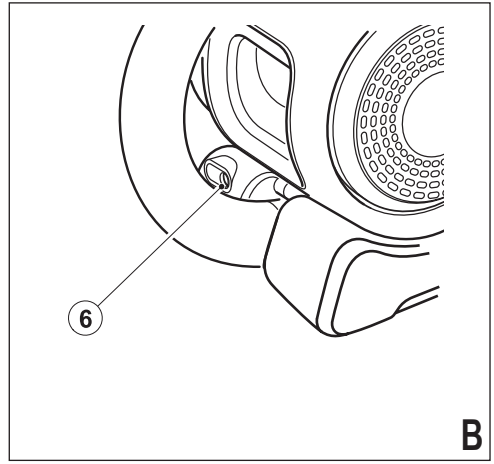
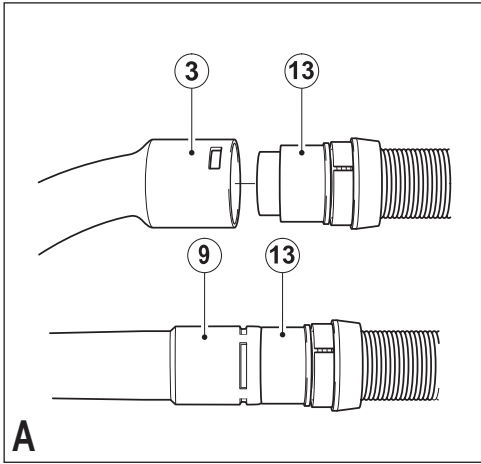

Intended use

Your Black & Decker Dustbuster Flexi™ vacuum cleaner has been designed for light dry vacuum cleaning purposes. This appliance is intended for household use only.

Safety instructions



Warning! Read all safety warnings and all instructions. Failure to follow the warnings and instructions listed below may result in electric shock, fire and/or serious injury.



Warning! When using battery-powered appliances, basic safety precautions, including the following, should always be followed to reduce the risk of fire, leaking batteries, personal injury and material damage.

- Read all of this manual carefully before using the appliance.
- The intended use is described in this manual. The use of any accessory or attachment or the performance of any operation with this appliance other than those recommended in this instruction manual may present a risk of personal injury.
- Retain this manual for future reference.

Using your appliance

- Do not use the appliance to pick up liquids or any materials that could catch fire.

- Do not use the appliance near water.
- Do not immerse the appliance in water.
- Never pull the charger lead to disconnect the charger from the socket. Keep the charger lead away from heat, oil and sharp edges.
- This appliance can be used by children aged from 8 years and above and persons with reduced physical, sensory or mental capabilities or lack of experience and knowledge if they have been given supervision or instruction concerning use of the appliance in a safe way and understand the hazards involved. Children shall not play with the appliance. Cleaning and user maintenance shall not be made by children without supervision.

Inspection and repairs

- Before use, check the appliance for damaged or defective parts. Check for breakage of parts, damage to switches and any other conditions that may affect its operation.
- Do not use the appliance if any part is damaged or defective.
- Have any damaged or defective parts repaired or replaced by an authorized repair agent.
- Regularly check the charger lead for damage. Replace the charger if the lead is damaged or defective.
- Never attempt to remove or replace any parts other than those specified in this manual.

Additional safety instructions

Residual risks.

Additional residual risks may arise when using the tool which may not be included in the enclosed safety warnings. These risks can arise from misuse, prolonged use etc. Even with the application of the relevant safety regulations and the implementation of safety devices, certain residual risks can not be avoided. These include:

- ♦ Injuries caused by touching any moving parts.
- ♦ Injuries caused by touching any hot parts.
- ♦ Injuries caused when changing any parts or accessories.
- ♦ Injuries caused by prolonged use of the appliance. When using any appliance for prolonged periods ensure you take regular breaks.

Batteries and chargers

Batteries

- ♦ Never attempt to open for any reason.
- ♦ Do not expose the battery to water.
- ♦ Do not expose the battery to heat.
- ♦ Do not store in locations where the temperature may exceed 40°C.
- ♦ Charge only at ambient temperatures between 10°C and 40°C.
- ♦ Charge only using the charger provided with the appliance/tool. Using the wrong charger could result in an

electric shock or overheating of the battery.

- ♦ When disposing of batteries, follow the instructions given in the section "Protecting the environment".
- ♦ Do not damage/deform the battery pack either by puncture or impact, as this may create a risk of injury and fire.
- ♦ Do not charge damaged batteries.
- ♦ Under extreme conditions, battery leakage may occur. When you notice liquid on the batteries carefully wipe the liquid off using a cloth. Avoid skin contact.
- ♦ In case of skin or eye contact, follow the instructions below.

Warning! The battery fluid may cause personal injury or damage to property. In case of skin contact, immediately rinse with water. If redness, pain or irritation occurs seek medical attention. In case of eye contact, rinse immediately with clean water and seek medical attention.

Chargers

Your charger has been designed for a specific voltage. Always check that the mains voltage corresponds to the voltage on the rating plate and the information in the technical data table.

Warning! Never attempt to replace the charger unit with a regular mains plug.

- ♦ Use your Black & Decker charger only to charge the battery in the appliance/tool with which it was supplied. Other

batteries could burst, causing personal injury and damage.

- ◆ Never attempt to charge nonrechargeable batteries.
- ◆ If the supply cord is damaged, it must be replaced by the manufacturer or an authorised Black & Decker Service Centre in order to avoid a hazard.
- ◆ Do not expose the charger to water.
- ◆ Do not open the charger.
- ◆ Do not probe the charger.
- ◆ The appliance/tool/battery must be placed in a well ventilated area when charging.



The charger automatically shuts off if the ambient temperature becomes too high. As a consequence the charger will be inoperable. The charging base must be disconnected from the mains supply and taken to an authorised service centre for repair.



The charging base is intended for indoor use only.

Electrical safety

Your charger has been designed for a specific voltage. Always check that the mains voltage corresponds to the voltage on the rating plate. Never attempt to replace the charger unit with a regular mains plug.

Symbols on the charger



Read all of this manual carefully before using the appliance.



This tool is double insulated; therefore no earth wire is required. Always check that the power supply corresponds to the voltage on the rating plate.



Short circuit proof safety isolating transformer. The mains supply is electrically separated from the transformer output.

Features

This appliance includes some or all of the following features.

1. On/off power switch
2. Removable hose/handle
3. Locking ring
4. Hose
5. Filter cleaning wheel
6. Transparent door
7. LED charging indicator
8. Door latch
9. 2-in-1 combi nozzle accessory
10. Accessory clip
11. Charging inlet

Assembly

Mounting accessories (fig. A)

The 2-in-1 combi nozzle (9) has a brush that can be folded forward for dusting and upholstery cleaning.

- ◆ To fit an accessory press the accessory clip (10) and slide the accessory onto the handle (2).
- ◆ To remove an accessory, press the accessory clip (10) and remove the accessory.

The handle (2) can be removed from the hose (4) allowing the accessories (9) to be connected directly to the hose cuff (13) when required.

To remove the handle:

- ◆ Unclip the handle (2) from the appliance.
- ◆ Rotate the locking ring (3) anti-clockwise to release the clips.
- ◆ Pull the hose (4) away from the handle (2).
- ◆ Fit the accessory directly to the hose cuff (13).

To refit the handle:

- ◆ Remove the accessory from the hose.
- ◆ Push the hose (4) into the handle (2). Rotate the locking ring (3) clockwise until it clicks into place.

Use

- ◆ Before first use, the battery must be charged.

Charging the battery (Fig. B)

- ◆ Make sure that the appliance is switched off. The battery will not be charged with the on/off power switch (1) in the on position.
- ◆ Insert the plug into the charging inlet (11) in the base.
- ◆ Plug in the charger and switch on at the mains.
- ◆ The charging indicator (7) will be lit.
- ◆ For the first charging, leave the appliance to charge for at least 24 hours.

While charging, the charger may become warm. This is normal and does not indicate a problem.

While it is safe to leave the appliance connected to the charger indefinitely, to reduce power consumption, we would recommend unplugging the charger after 24 hours. The charging indicators will be lit as long as the appliance is connected to the plugged-in charger.

Warning! Do not charge the battery at ambient temperatures below 10 °C or above 40 °C.

Switching on and off

- ◆ To switch the appliance on, slide the on/off power switch (1) to the right to position 1.
- ◆ To switch the appliance off, slide the on/off power switch (1) to the left until it clicks into the off position.

Vacuuming

- ◆ When operating the appliance, make sure that the hose is not trapped, twisted or blocked.
- ◆ The handle (2) can be easily removed from the appliance allowing you to reach up to 1.5 m from the appliance.
- ◆ With the handle (2) removed, the appliance can be carried using the built-in handle.
- ◆ The handle (2) can also be removed from the hose (4) so that you can connect an accessory directly to the hose cuff (13) when required.

Hints for optimum use

- ◆ When vacuuming stairs, always start at the bottom and work your way up.

Optimising the suction force

In order to keep the suction force optimised, the filters must be cleared regularly during use.

- ◆ Turn the filter cleaning wheel (5) two turns clockwise to remove out any dust from the filters.
- ◆ The fine particulate filter must be cleaned regularly, see "Cleaning the fine particulate filter" section.

Cleaning and maintenance**Emptying the dust container (fig.C)**

The dust container must be emptied regularly, preferably after every use.

- ◆ Release the door catch (8) and open the transparent door (6) 180° until it clicks in the open position.
- ◆ Remove the pre-filter (14).
- ◆ Empty the dust container.
- ◆ Clean the pre-filter (14) by lightly shaking over a dustbin.
- ◆ Refit the pre-filter (14).
- ◆ Close the transparent door (6) and make sure that it clicks into place.

Warning! Do not, under any circumstances, rinse out the dust container.

Warning! Do not immerse the appliance in water. A damp cloth and soapy water should be used to clean the exterior of the appliance. Always make sure that the appliance is completely dry before re-use or storing.

Cleaning the fine particulate filter (fig.D)

The fine particulate filter (15) prevents particles and larger objects from entering the motor housing.

The filter (15) is re-usable and should be cleaned regularly.

- ◆ Remove the pre-filter (14) from the appliance as described above.
- ◆ Remove the fine particulate filter (15) by pulling firmly.
- ◆ Tap the filter vigorously to remove loose dust from the filter.
- ◆ If necessary, wash the filter in warm, soapy water.
- ◆ Make sure that the filters are dry.
- ◆ Refit the fine particulate filter (15) on to the appliance.
- ◆ Refit the pre-filter (14) as described above.

Replacing the filters

The filters should be replaced every 6 to 9 months and whenever worn or damaged. Replacement filters are available from your Black & Decker dealer (cat. no. PD10):

- ◆ Remove the old filters as described above.
- ◆ Fit the new filters as described above.

Protecting the environment



Separate collection. This product must not be disposed of with normal household waste.

Should you find one day that your Black & Decker product needs replacement, or if it is of no further use to you, do not dispose of it with household waste. Make this product available for separate collection.



Separate collection of used products and packaging allows materials to be recycled and used again. Re-use of recycled materials helps prevent environmental pollution and reduces the demand for raw materials.

Local regulations may provide for separate collection of electrical products from the household, at municipal waste sites or by the retailer when you purchase a new product.

Black & Decker provides a facility for the collection and recycling of Black & Decker products once they have reached the end of their working life. To take advantage of this service please return your product to any authorised repair agent who will collect them on our behalf.

You can check the location of your nearest authorised repair agent by contacting your local Black & Decker office at the address indicated in this manual. Alternatively, a list of authorised Black & Decker repair agents and full details of our after-sales service and contacts are available on the Internet at: www.2helpU.com

Battery



If you want to dispose of the product yourself, the battery must be removed as described below and disposed of in accordance with local regulations.

- ◆ Discharge the battery by operating the appliance until the motor stops.
- ◆ Invert the appliance to get access to the screws that attach the base.
- ◆ Remove the 4 screws.
- ◆ Remove the base.
- ◆ Disconnect the 3-pin connector.
- ◆ Place the battery in suitable packaging to ensure that the terminals cannot be short-circuited.
- ◆ Take the battery to your service agent or to a local recycling station.

Once removed, the battery can not be refitted.

Technical data

		PD1202N (H1)
Voltage	V_{dc}	12
Battery	Type	NiMH
Weight	kg	1.7
Charger		VA170020D BA170020D
Input voltage	V_{ac}	230
Output voltage	V	17 _{ac}
Current	mA	200
Approximate charge time	h	16
Weight	kg	0.2

Guarantee

Black & Decker is confident of the quality of its products and offers an outstanding guarantee. This guarantee statement is in addition to and in no way prejudices your statutory rights. The guarantee is valid within the territories of the Member States of the European Union and the European Free Trade Area.

If a Black & Decker product becomes defective due to faulty materials, workmanship or lack of conformity, within 24 months from the date of purchase, Black & Decker guarantees to replace defective parts, repair products subjected to fair wear and tear or replace such products to ensure minimum inconvenience to the customer unless:

- ◆ The product has been used for trade, professional or hire purposes;
- ◆ The product has been subjected to misuse or neglect;
- ◆ The product has sustained damage through foreign objects, substances or accidents;
- ◆ Repairs have been attempted by persons other than authorised repair agents or Black & Decker service staff.

To claim on the guarantee, you will need to submit proof of purchase to the seller or an authorised repair agent. You can check the location of your nearest authorised repair agent by contacting your local Black & Decker office at the address indicated in this manual. Alternatively, a list of authorised Black & Decker repair agents and full details of our after-sales service and contacts are available on the Internet at: www.2helpU.com

Please visit our website www.blackanddecker.co.uk to register your new Black & Decker product and to be kept up to date on new products and special offers. Further information on the Black & Decker brand and our range of products is available at www.blackanddecker.co.uk

Australia

Black & Decker (Australia) Pty. Ltd.
20 Fletcher Road, Mooroolbark,
Victoria, 3138

Tel. 03-8720 5100
Fax 03-9727 5940

New Zealand

Black & Decker
5 Te Apunga Place
Mt Wellington
Auckland 1060

Tel. +64 9 259 1133
Fax +64 9 259 1122

United Kingdom

Black & Decker
210 Bath Road
Slough, Berkshire SL1 3YD

Tel. 01753 511234
Fax 01753 551155